

PLIXI®

Laterale - Lateral

Dati Tecnici

Altezza massima: 3000 [mm]
 Larghezza massima: 1800 [mm]
 Ingombro min: 22 [mm]

Data Sheet

Maximum height: 3000 [mm]
 Maximum width: 1800 [mm]
 Min Space: 22 [mm]

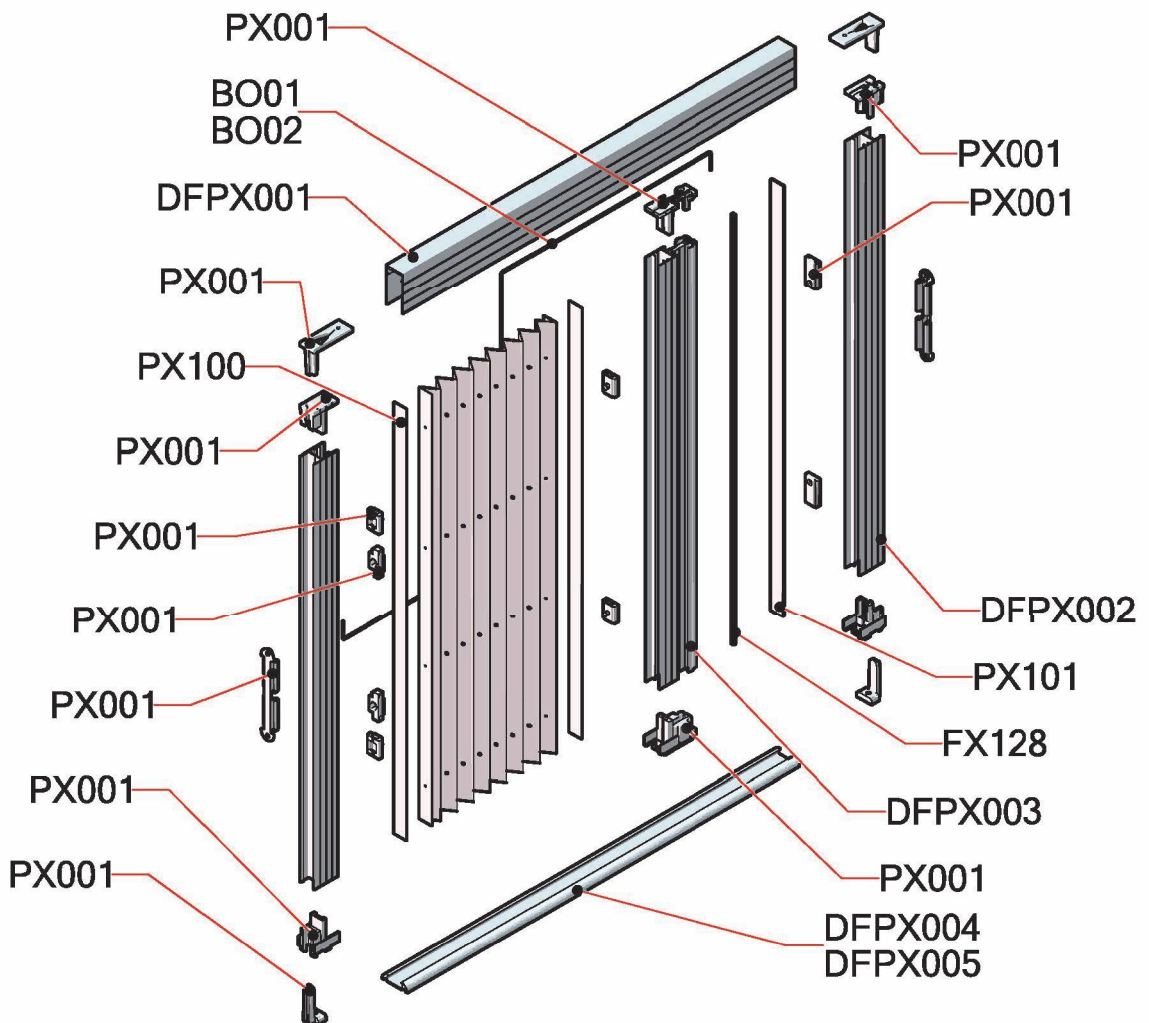
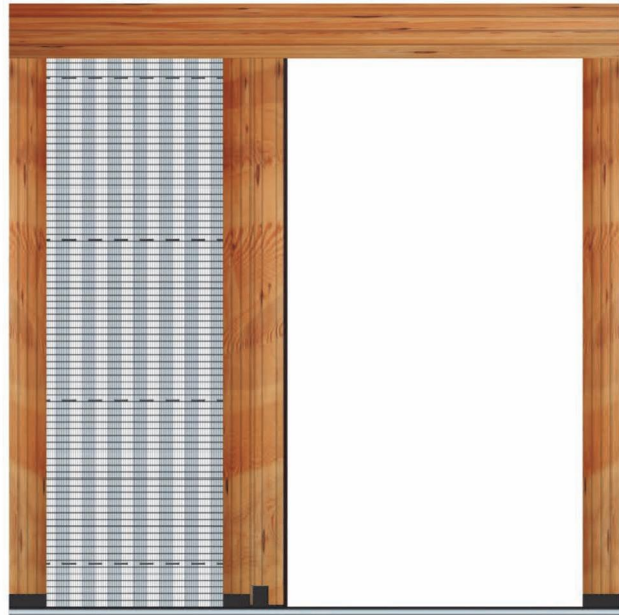

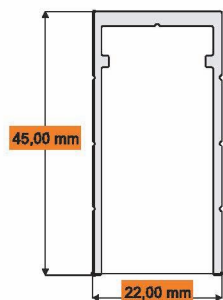
Profili di alluminio specifici - Specific aluminium profiles
Guida superiore - Upper guide

Dati Tecnici

Codice: DFPX001
 Materiale: EN-AW 6060 T5
 Peso nominale: 383 g/mt
 Finitura: Grezzo - Verniciatura

Data Sheet

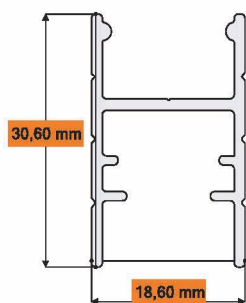
Code: DFPX001
 Material: EN-AW 6060 T5
 Nominal weight: 383 g/mt
 Finishing: Raw - Painting

Guida laterale - Lateral guide

Dati Tecnici

Codice: DFPX002
 Materiale: FN-AW 6060 T5
 Peso nominale: 309 g/mt
 Finitura: Grezzo - Verniciatura

Data Sheet

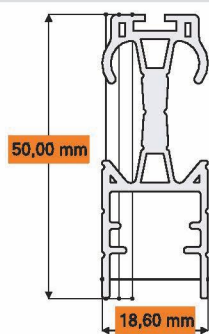
Code: DFPX002
 Material: EN-AW 6060 T5
 Nominal weight: 309 g/mt
 Finishing: Raw - Painting

Barra maniglia - Handle bar

Dati Tecnici

Codice: DFPX003
 Materiale: EN-AW 6060 T5
 Peso nominale: 733 g/mt
 Finitura: Grezzo - Verniciatura

Data Sheet

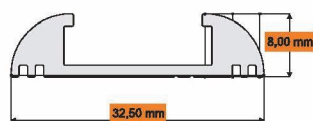
Code: DFPX003
 Material: EN-AW 6060 T5
 Nominal weight: 733 g/mt
 Finishing: Raw - Painting

Guida inferiore - Lower guide

Dati Tecnici

Codice: DFPX004
 Materiale: EN-AW 6060 T5
 Peso nominale: 295 g/mt
 Finitura: Grezzo - Verniciatura

Data Sheet

Code: DFPX004
 Material: EN-AW 6060 T5
 Nominal weight: 295 g/mt
 Finishing: Raw - Painting

Dati Tecnici

Codice: DFPX005
 Materiale: EN-AW 6060 T5
 Peso nominale: 151 g/mt
 Finitura: Grezzo - Verniciatura

Data Sheet

Code: DFPX005
 Material: EN-AW 6060 T5
 Nominal weight: 151 g/mt
 Finishing: Raw - Painting

PLIXI®

Laterale - Lateral

Soluzione di base - Basic solution







Questa soluzione prevede l'acquisto di tutti i componenti sciolti, necessari alla realizzazione del sistema.
È fondamentale quindi che chi acquista abbia a disposizione le macchine e le attrezzature necessarie per la lavorazione.

This solution provides the purchase of all loose components required for manufacturing the pleated system.
The machine and the tools are necessary to proceed with production.

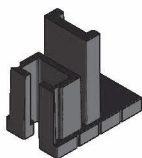
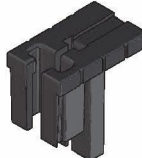
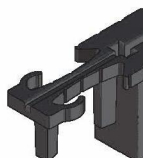
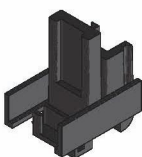
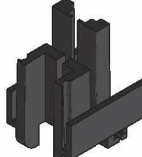
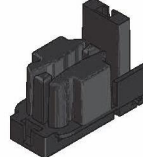
Accessori per soluzione base - Accessories for basic solution

codice - code: PX001

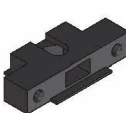
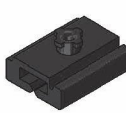
Confezione: 100 kit (min)
Packing: 100 sets (min)

 <p>Tappo superiore Dati Tecnici Materiale: PA6 Confezione: 1 pezzo Upper plug Data Sheet Material: PA6 Packing: 1 piece</p>	 <p>Tappo superiore per filo Dati Tecnici Materiale: PA6 Confezione: 1 pezzo Upper plug for wire Data Sheet Material: PA6 Packing: 1 piece</p>	 <p>Tappo supe. barra maniglia Dati Tecnici Materiale: PA6 Confezione: 1 pezzo Upper plug for handlebar Data Sheet Material: PA6 Packing: 1 piece</p>
 <p>Tappo inferiore Dati Tecnici Materiale: PA6 Confezione: 1 pezzo Lower plug Data Sheet Material: PA6 Packing: 1 piece</p>	 <p>Tappo inferiore per filo Dati Tecnici Materiale: PA6 Confezione: 1 pezzo Lower plug for wire Data Sheet Material: PA6 Packing: 1 piece</p>	 <p>Tappo infe. barramaniglia Dati Tecnici Materiale: PA6 Confezione: 1 pezzo Lower plug for handlebar Data Sheet Material: PA6 Packing: 1 piece</p>
 <p>Clip aggancio rapido Dati Tecnici Materiale: PA6 Confezione: 6 pezzi Clip for quick hook Data Sheet Material: PA6 Packing: 6 pieces</p>	 <p>Aggancio inf. regolabile Dati Tecnici Materiale: PA6 Confezione: 2 pezzi Lower adjustable bracket Data Sheet Material: PA6 Packing: 2 pieces</p>	 <p>Aggancio supe. regolabile Dati Tecnici Materiale: PA6 Confezione: 2 pezzi Upper adjustable bracket Data Sheet Material: PA6 Packing: 2 pieces</p>
 <p>Terminale filo Dati Tecnici Materiale: PA6 Confezione: 6 pezzi End cap for wire Data Sheet Material: PA6 Packing: 6 pieces</p>	 <p>Passante per filo rete Dati Tecnici Materiale: PA6 Confezione: 12 pezzi Passage for wire Data Sheet Material: PA6 Packing: 12 pieces</p>	 <p>Basetta di taratura filo Dati Tecnici Materiale: PA6 Confezione: 2 pezzi Calibration base for wire Data Sheet Material: PA6 Packing: 2 pieces</p>

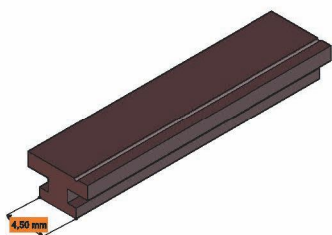
Accessori base - Basic accessories
Banda magnetica - Magnetic band

Dati Tecnici
 Codice: **FX128**
 Per guida: DFPX003
 Confezione: 250/300 metri (min)

Data Sheet
 Code: **FX128**
 For guide: DFPX003
 Packing: 250/300 meters

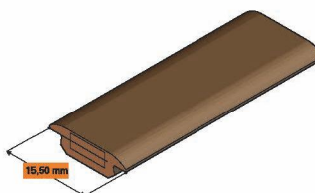
Banda magnetica - Magnetic band

Dati Tecnici
 Codice: **PX101**
 Per guida: DFPX002
 Confezione: 250/300 metri (min)

Data Sheet
 Code: **PX101**
 For guide: DFPX002
 Packing: 250/300 meters

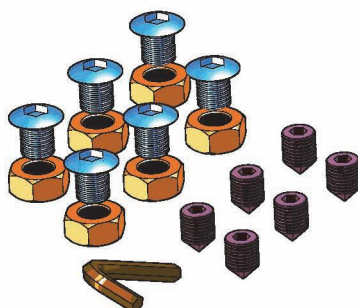
Kit viteria per assemblaggio - Kit screws for assembly

Dati Tecnici
 Codice: **PX102**
 Materiale: ZBD 3 + Cr3
 Confezione: 100 kit (min)

Data Sheet
 Code: **PX102**
 Material: ZBD 3 + Cr3
 Packing: 100 sets (min)

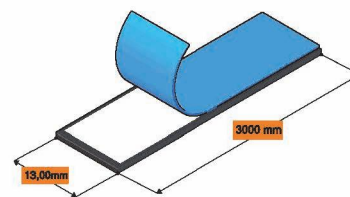
Piattina con biadesivo - Flat with double-sided tape

Dati Tecnici
 Codice: **PX100**
 Materiale: PP
 Dimensioni : 13x1mm L= 2,4 - 2,6 - 3mt
 Confezione: 200 pezzi (min)

Data Sheet
 Code: **PX100**
 Material: PP
 Size: 13x1mm L= 2,4 - 2,6 - 3mt
 Packing: 200 pieces (min)

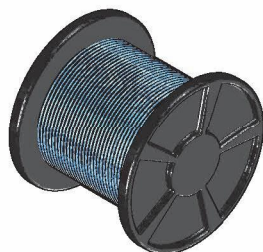
Bobina di filo - Reel wire

Dati Tecnici
 Codice: **BO01GR**
 Materiale: Poliestere
 Confezione: 1.000 metri (min)

Data Sheet
 Code: **BO01GR**
 Material: Polyester
 Packing: 1.000 meters (min)

PLIXI®

Laterale - Lateral

Soluzione in KIT - KIT solution

Questa soluzione prevede l'acquisto di KIT rete preconfigurati completamente assemblati, riducibili in altezza a seconda delle necessità fino a 30 cm. In questo modo i tempi di realizzazione e di montaggio del sistema saranno ridotti notevolmente, oltre a non dover necessitare di macchine specifiche per la lavorazione. I rimanenti accessori per il completamento della zanzariera vanno acquistati separatamente.

This solution provides the purchase of pre-assembled kits of mesh, with the possibility to reduce the heights according to the needs. In this way the times of manufacture for assembly the system will be reduced considerably: no specific machines are required for production. The remaining accessories for completing the insect screen must be purchased separately.

CODICE CODE	RETE PLISSÈ PLEATED NET				FILO WIRE	PIATTINA FLAT
	ALTEZZA HEIGHT	LARGHEZZA WIDTH	SPESSORE THICKNESS	COLORE COLOR	CODICE CODE	LUNGHEZZA LENGTH
PXKIT170125G	1,70 [mt]	96/125 [cm]	15 [mm]	GRIGIO GRAY	BO01	1,70 [mt]
PXKIT170150G	1,70 [mt]	126/150 [cm]	15 [mm]	GRIGIO GRAY	BO01	1,70 [mt]
PXKIT200125G	2,00 [mt]	96/125 [cm]	15 [mm]	GRIGIO GRAY	BO01	2,00 [mt]
PXKIT200150G	2,00 [mt]	126/150 [cm]	15 [mm]	GRIGIO GRAY	BO01	2,00 [mt]
PXKIT230125G	2,30 [mt]	96/125 [cm]	15 [mm]	GRIGIO GRAY	BO01	2,30 [mt]
PXKIT230150G	2,30 [mt]	126/150 [cm]	15 [mm]	GRIGIO GRAY	BO01	2,30 [mt]
PXKIT260125G	2,60 [mt]	96/125 [cm]	15 [mm]	GRIGIO GRAY	BO01	2,60 [mt]
PXKIT260150G	2,60 [mt]	126/150 [cm]	15 [mm]	GRIGIO GRAY	BO01	2,60 [mt]
PXKIT300125G	3,00 [mt]	96/125 [cm]	15 [mm]	GRIGIO GRAY	BO01	3,00 [mt]
PXKIT300150G	3,00 [mt]	126/150 [cm]	15 [mm]	GRIGIO GRAY	BO01	3,00 [mt]

Nota:

I kit preconfigurati elencati sono da considerarsi completi di:

- fissaggio delle 2 piattine alle estremità delle rete;
- Foratura di rete e piattine;
- Inserimento dei fili in poliestere;
- Assemblaggio degli accessori specifici direttamente nel kit.

Notice:

The pre-assembled kits above include:

- 2 flats already placed on the edges of mesh;
- Drilling of mesh and flats;
- Polyester wire insertion;
- Components already placed on the kit mesh.

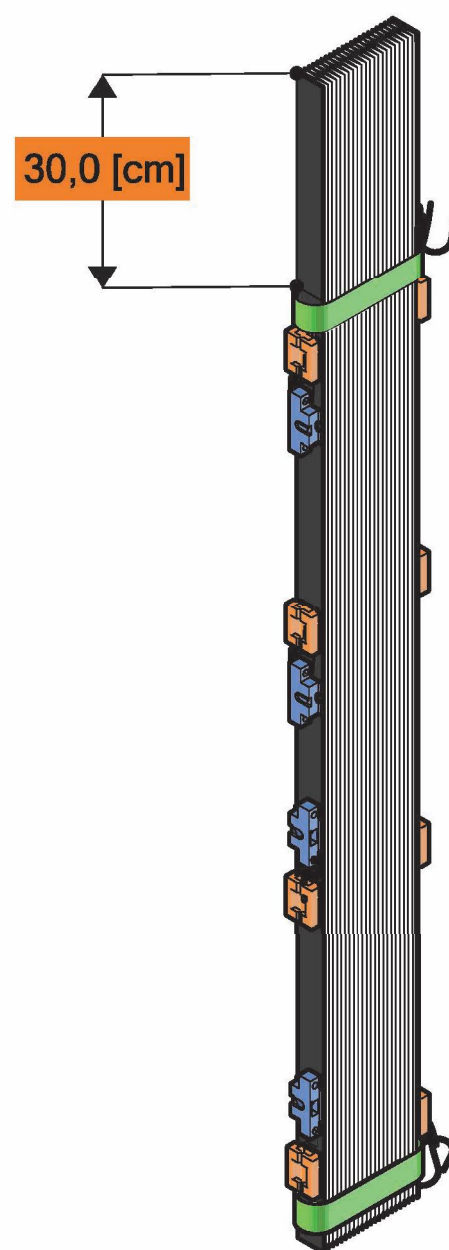

Soluzione in KIT - KIT solution

Accessori per soluzione in kit - Accessories for kit solution

codice - code: PX003

Confezione: 100 kit (min)
Packing: 100 sets (min)

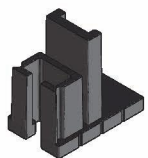

Tappo superiore
Dati Tecnici
Materiale: PA6
Confezione: 1 pezzo

Upper plug
Data Sheet
Material: PA6
Packing: 1 piece

CP-001



Tappo superiore per filo
Dati Tecnici
Materiale: PA6
Confezione: 1 pezzo

Upper plug for wire
Data Sheet
Material: PA6
Packing: 1 piece

CP-005

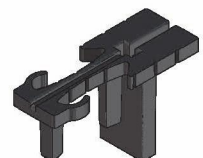

Tappo superiore barra maniglia
Dati Tecnici
Materiale: PA6
Confezione: 1 pezzo

Upper plug for handlebar
Data Sheet
Material: PA6
Packing: 1 piece

CP-007

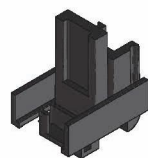

Tappo inferiore
Dati Tecnici
Materiale: PA6
Confezione: 1 pezzo

Lower plug
Data Sheet
Material: PA6
Packing: 1 piece

CP-003

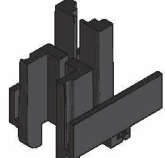

Tappo inferiore per filo
Dati Tecnici
Materiale: PA6
Confezione: 1 pezzo

Lower plug for wire
Data Sheet
Material: PA6
Packing: 1 piece

CP-006

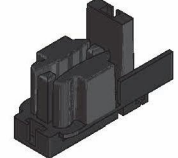

Tappo inferiore barramaniglia
Dati Tecnici
Materiale: PA6
Confezione: 1 pezzo

Lower plug for handlebar
Data Sheet
Material: PA6
Packing: 1 piece

CP-008



Clip aggancio rapido
Dati Tecnici
Materiale: PA6
Confezione: 6 pezzi

Clip for quick hook
Data Sheet
Material: PA6
Packing: 6 pieces

CP-009



Aggancio inferiore regolabile
Dati Tecnici
Materiale: PA6
Confezione: 2 pezzi

Lower adjustable bracket
Data Sheet
Material: PA6
Packing: 2 pieces

CP-004



Aggancio superiore regolabile
Dati Tecnici
Materiale: PA6
Confezione: 2 pezzi

Upper adjustable bracket
Data Sheet
Material: PA6
Packing: 2 pieces

CP-002



Basetta di taratura filo
Dati Tecnici
Materiale: PA6
Confezione: 2 pezzi

Calibration base for wire
Data Sheet
Material: PA6
Packing: 2 pieces

CP-012

PLIXI®

Laterale - Lateral

Accessori base - Basic accessories

Banda magnetica - Magnetic band

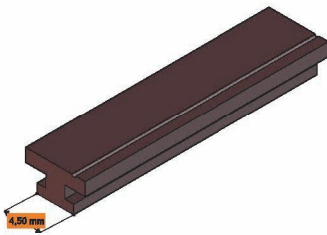

Dati Tecnici

Codice: FX128
Per guida: DFPX003
Confezione: 250/300 metri (min)

Data Sheet

Code: FX128
For guide: DFPX003
Packing: 250/300 meters

Banda magnetica - Magnetic band

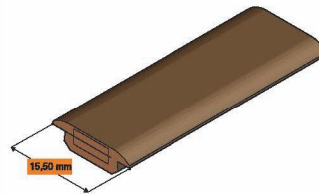

Dati Tecnici

Codice: PX101
Per guida: DFPX002
Confezione: 250/300 metri (min)

Data Sheet

Code: PX101
For guide: DFPX002
Packing: 250/300 meters

Kit viteria per assemblaggio - Kit screws for assembly

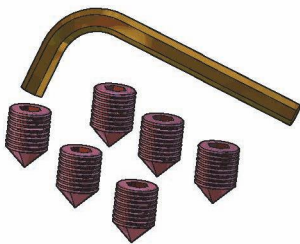

Dati Tecnici

Codice: PX108
Materiale: ZBD 3 + Cr3
Confezione: 100 kit (min)

Data Sheet

Code: PX108
Material: ZBD 3 + Cr3
Packing: 100 sets (min)

Alternative tra accessori - Alternative accessories

Alternativa 1 - Alternative 1

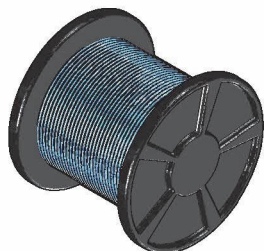

BOBINA DI FILO poliestere

Dati Tecnici

Codice: **BO01GR**
 Materiale: Poliestere
 Confezione: 1.000 metri (min)

REEL WIRE polyester

Data Sheet

Code: **BO01GR**
 Material: Polyester
 Packing: 1.000 meters (min)

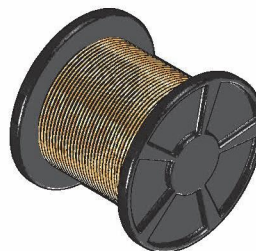

BOBINA DI FILO kevlar

Dati Tecnici

Codice: **BO02**
 Materiale: Kevlar
 Confezione: 1.000 metri (min)

REEL WIRE kevlar

Data Sheet

Code: **BO02**
 Material: Kevlar
 Packing: 1.000 meters (min)

PLIXI®

Laterale doppia - Double lateral

Dati Tecnici

- Altezza massima: 3000 [mm]
- Larghezza massima: 3000 [mm]
- Ingombro min: 22 [mm]
- Ingombro max: 32,5 [mm]

Data Sheet

- Maximum height: 3000 [mm]
- Maximum width: 3000 [mm]
- Min space: 22 [mm]
- Max Space: 32,5 [mm]

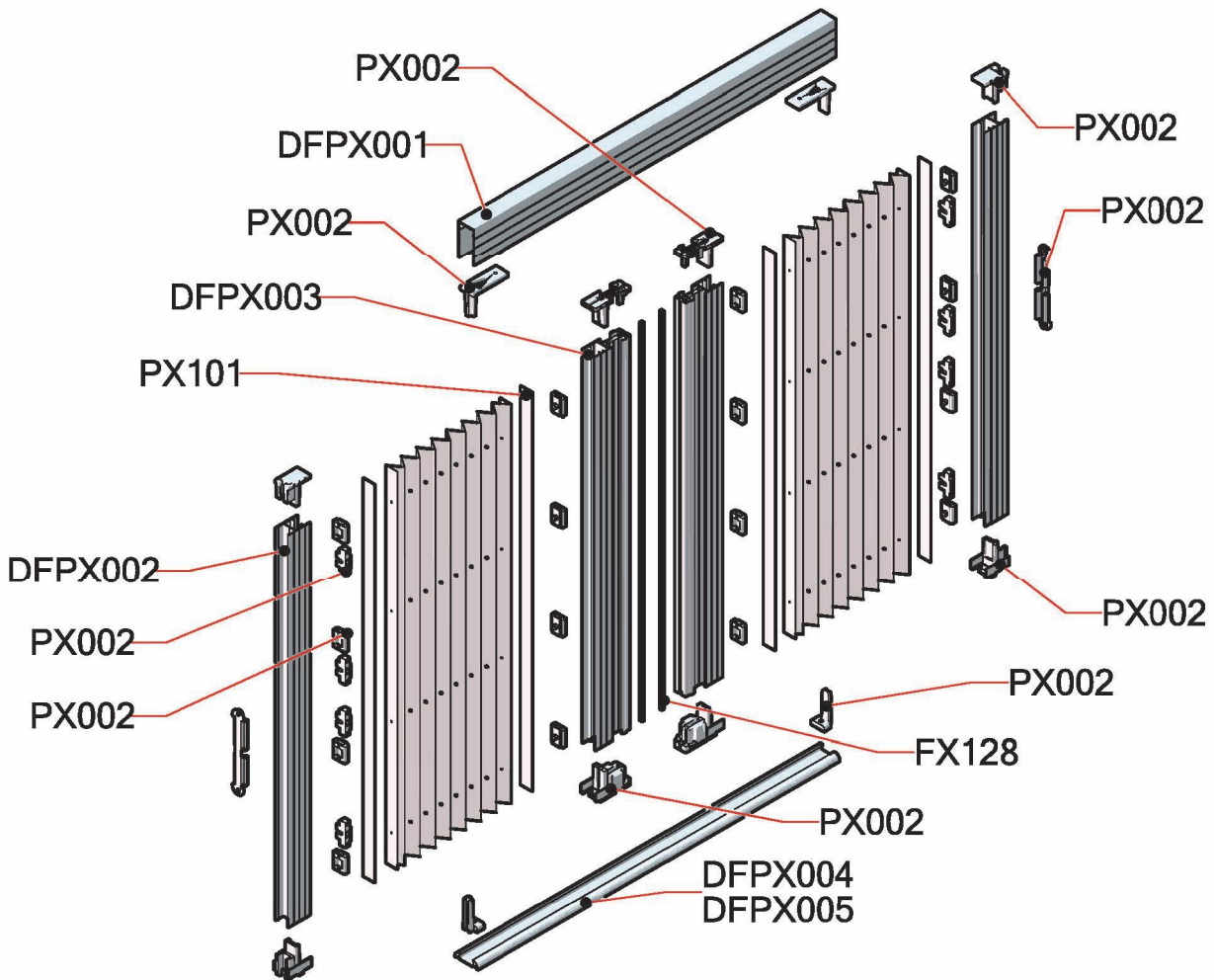
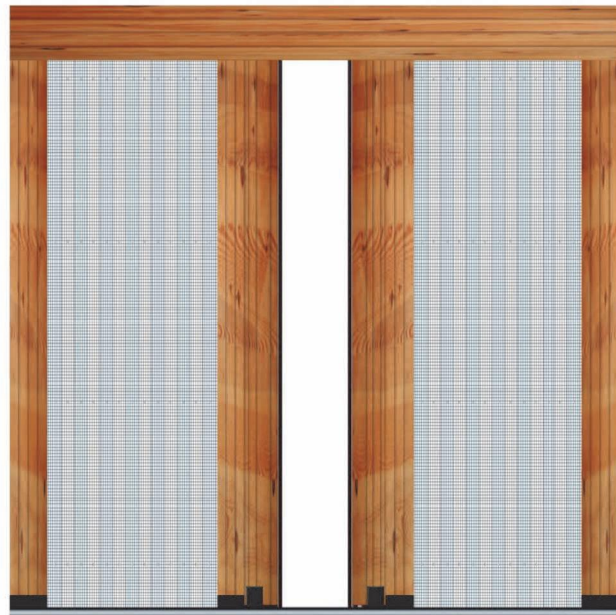

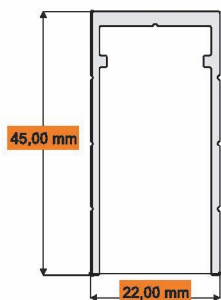
Profili di alluminio specifici - Specific aluminium profiles
Guida superiore - Upper guide

Dati Tecnici

Codice: DFPX001
 Materiale: EN-AW 6060 T5
 Peso nominale: 383 g/mt
 Finitura: Grezzo - Verniciatura

Data Sheet

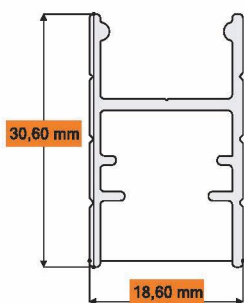
Code: DFPX001
 Material: EN-AW 6060 T5
 Nominal weight: 383 g/mt
 Finishing: Raw - Painting

Guida laterale - Lateral guide

Dati Tecnici

Codice: DFPX002
 Materiale: FN-AW 6060 T5
 Peso nominale: 309 g/mt
 Finitura: Grezzo - Verniciatura

Data Sheet

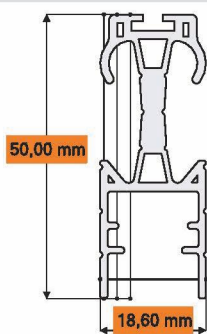
Code: DFPX002
 Material: EN-AW 6060 T5
 Nominal weight: 309 g/mt
 Finishing: Raw - Painting

Barra maniglia - Handle bar

Dati Tecnici

Codice: DFPX003
 Materiale: EN-AW 6060 T5
 Peso nominale: 733 g/mt
 Finitura: Grezzo - Verniciatura

Data Sheet

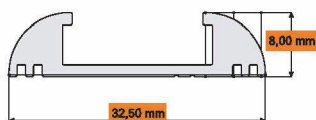
Code: DFPX003
 Material: EN-AW 6060 T5
 Nominal weight: 733 g/mt
 Finishing: Raw - Painting

Guida inferiore - Lower guide

Dati Tecnici

Codice: DFPX004
 Materiale: EN-AW 6060 T5
 Peso nominale: 295 g/mt
 Finitura: Grezzo - Verniciatura

Data Sheet

Code: DFPX004
 Material: EN-AW 6060 T5
 Nominal weight: 295 g/mt
 Finishing: Raw - Painting

Dati Tecnici

Codice: DFPX005
 Materiale: EN-AW 6060 T5
 Peso nominale: 151 g/mt
 Finitura: Grezzo - Verniciatura

Data Sheet

Code: DFPX005
 Material: EN-AW 6060 T5
 Nominal weight: 151 g/mt
 Finishing: Raw - Painting









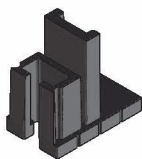

PLIXI®
Laterale doppia - Double lateral
Soluzione di base - Basic solution

Questa soluzione prevede l'acquisto di tutti i componenti sciolti, necessari alla realizzazione del sistema.
È fondamentale quindi che chi acquista abbia a disposizione le macchine e le attrezzature necessarie per la lavorazione.

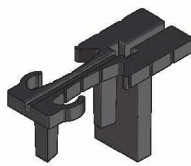
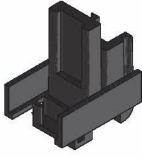
This solution provides the purchase of all loose components required for manufacturing the pleated system.
The machine and the tools are necessary to proceed with production.

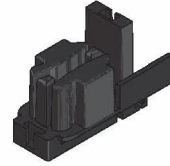
Accessori per soluzione base - Accessories for basic solution
codice - code: PX002

Confezione: 100 kit (min)
Packing: 100 sets (min)

 <p>Tappo superiore Dati Tecnici Materiale: PA6 Confezione: 2 pezzi Upper plug Data Sheet Material: PA6 Packing: 2 pieces</p>	 <p>Terminale filo Dati Tecnici Materiale: PA6 Confezione: 12 pezzi End cap for wire Data Sheet Material: PA6 Packing: 12 pieces</p>	 <p>Tappo supe. barra maniglia Dati Tecnici Materiale: PA6 Confezione: 2 pezzi Upper plug for handlebar Data Sheet Material: PA6 Packing: 2 pieces</p>
 <p>Tappo inferiore Dati Tecnici Materiale: PA6 Confezione: 2 pezzi Lower plug Data Sheet Material: PA6 Packing: 2 pieces</p>	 <p>Passante per filo rete Dati Tecnici Materiale: PA6 Confezione: 24 pezzi Passage for wire Data Sheet Material: PA6 Packing: 24 pieces</p>	 <p>Tappo infe. barramaniglia Dati Tecnici Materiale: PA6 Confezione: 2 pezzi Lower plug for handlebar Data Sheet Material: PA6 Packing: 2 pieces</p>
 <p>Clip aggancio rapido Dati Tecnici Materiale: PA6 Confezione: 6 pezzi Clip for quick hook Data Sheet Material: PA6 Packing: 6 pieces</p>	 <p>Aggancio inf. regolabile Dati Tecnici Materiale: PA6 Confezione: 2 pezzi Lower adjustable bracket Data Sheet Material: PA6 Packing: 2 pieces</p>	 <p>Aggancio supe. regolabile Dati Tecnici Materiale: PA6 Confezione: 2 pezzi Upper adjustable bracket Data Sheet Material: PA6 Packing: 2 pieces</p>

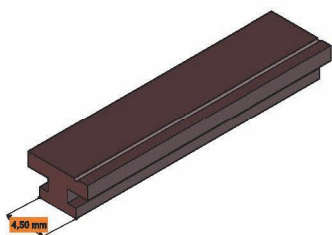
Accessori base - Basic accessories
Banda magnetica - Magnetic band

Dati Tecnici

Codice: **FX128**
 Per guida: DFPX003
 Confezione: 250/300 metri (min)

Data Sheet

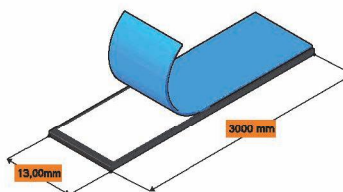
Code: **FX128**
 For guide: DFPX003
 Packing: 250/300 meters

Piattina con biadesivo - Flat with double-sided tape

Dati Tecnici

Codice: **PX100**
 Materiale: PP
 Dimensioni : 13x1mm L= 2,4 - 2,6 - 3mt
 Confezione: 200 pezzi (min)

Data Sheet

Code: **PX100**
 Material: PP
 Size: 13x1mm L= 2,4 - 2,6 - 3mt
 Packing: 200 pieces (min)

Kit viteria per assemblaggio - Kit screws for assembly

Dati Tecnici

Codice: **PX103**
 Materiale: ZBD 3 + Cr3
 Confezione: 100 kit (min)

Data Sheet

Code: **PX103**
 Material: ZBD 3 + Cr3
 Packing: 100 sets (min)

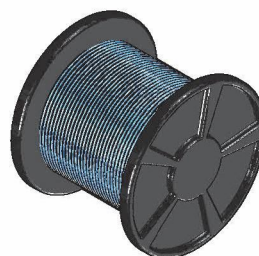
Bobina di filo - Reel wire

Dati Tecnici

Codice: **BO01GR**
 Materiale: Poliestere
 Confezione: 1.000 metri (min)

Data Sheet

Code: **BO01GR**
 Material: Polyester
 Packing: 1.000 meters (min)

PLIXI®

Laterale doppia - Double lateral

Soluzione in kit a misura - Customised Kit solution

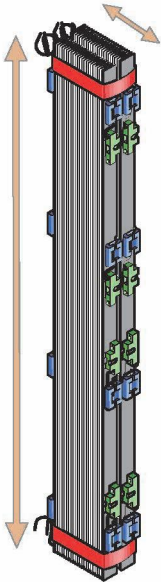

Questa soluzione prevede l'acquisto di KIT rete preconfigurati completamente assemblati, con altezza e larghezza su misura (è necessario fornire anticipatamente le misure del foro luce).

In questo modo i tempi di realizzazione e di montaggio del sistema saranno ridotti notevolmente, oltre a non dover necessitare di macchine specifiche per la lavorazione. I rimanenti accessori per il completamento della zanzariera vanno acquistati separatamente.

This solution provides the purchase of pre-assembled KIT mesh, with height and width cut to size (you must provide in advance sizes of the window/door).





In this way the times for manufacturing and assembling the system will be reduced considerably: no specific machines are required for production.

The remaining accessories for completing the insect screen must be purchased separately.

Accessori per soluzione in kit - Accessories for kit solution

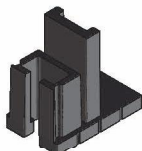
codice - code: PX004

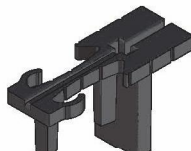
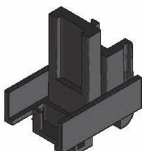
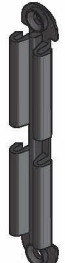
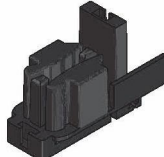
Confezione: 100 kit (min)
Packing: 100 sets (min)

 <p>Tappo superiore Dati Tecnici Materiale: PA6 Confezione: 2 pezzi Upper plug Data Sheet Material: PA6 Packing: 2 pieces</p> <p>CP-001</p>	 <p>Aggancio inf. regolabile Dati Tecnici Materiale: PA6 Confezione: 2 pezzi Lower adjustable bracket Data Sheet Material: PA6 Packing: 2 pieces</p> <p>CP-004</p>	 <p>Tappo supe. barra maniglia Dati Tecnici Materiale: PA6 Confezione: 2 pezzi Upper plug for handlebar Data Sheet Material: PA6 Packing: 2 pieces</p> <p>CP-007</p>
 <p>Tappo inferiore Dati Tecnici Materiale: PA6 Confezione: 2 pezzi Lower plug Data Sheet Material: PA6 Packing: 2 pieces</p> <p>CP-003</p>	 <p>Clip aggancio rapido Dati Tecnici Materiale: PA6 Confezione: 6 pezzi Clip for quick hook Data Sheet Material: PA6 Packing: 6 pieces</p> <p>CP-009</p>	 <p>Tappo infe. barramaniglia Dati Tecnici Materiale: PA6 Confezione: 2 pezzi Lower plug for handlebar Data Sheet Material: PA6 Packing: 2 pieces</p> <p>CP-008</p>
		 <p>Aggancio supe. regolabile Dati Tecnici Materiale: PA6 Confezione: 2 pezzi Upper adjustable bracket Data Sheet Material: PA6 Packing: 2 pieces</p> <p>CP-002</p>

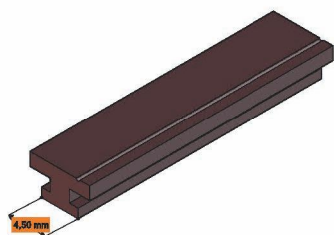
Accessori base - Basic accessories
Banda magnetica - Magnetic band

Dati Tecnici

Codice: **FX128**
 Per guida: DFPX003
 Confezione: 250/300 metri (min)

Data Sheet

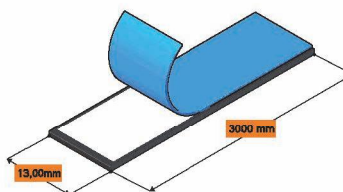
Code: **FX128**
 For guide: DFPX003
 Packing: 250/300 meters

Piattina con biadesivo - Flat with double-sided tape

Dati Tecnici

Codice: **PX100**
 Materiale: PP
 Dimensioni : 13x1mm L= 2,4 - 2,6 - 3mt
 Confezione: 200 pezzi (min)

Data Sheet

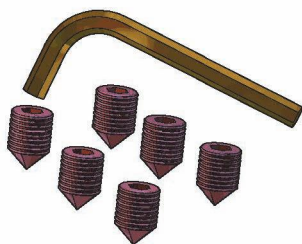
Code: **PX100**
 Material: PP
 Size: 13x1mm L= 2,4 - 2,6 - 3mt
 Packing: 200 pieces (min)

Kit viteria per assemblaggio - Kit screws for assembly

Dati Tecnici

Codice: **PX108**
 Materiale: ZBD 3 + Cr3
 Confezione: 100 kit (min)

Data Sheet

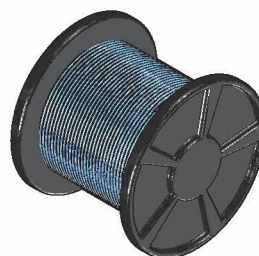
Code: **PX108**
 Material: ZBD 3 + Cr3
 Packing: 100 sets (min)

Bobina di filo - Reel wire

Dati Tecnici

Codice: **BO01GR**
 Materiale: Poliestere
 Confezione: 1.000 metri (min)

Data Sheet

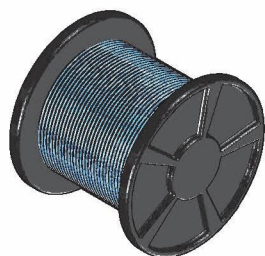
Code: **BO01GR**
 Material: Polyester
 Packing: 1.000 meters (min)

Alternative tra accessori - Alternative accessories
Alternativa 1 - Alternative 1

BOBINA DI FILO poliestere
Dati Tecnici

Codice: **BO01GR**
 Materiale: Poliestere
 Confezione: 1.000 metri (min)

REEL WIRE polyester
Data Sheet

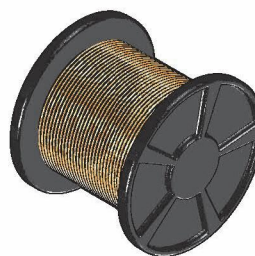
Code: **BO01GR**
 Material: Polyester
 Packing: 1.000 meters (min)

BOBINA DI FILO kevlar
Dati Tecnici

Codice: **BO02**
 Materiale: Kevlar
 Confezione: 1.000 metri (min)

REEL WIRE kevlar
Data Sheet

Code: **BO02**
 Material: Kevlar
 Packing: 1.000 meters (min)

PLIXI®

Reverse

Dati Tecnici

Altezza massima: 3000 [mm]
 Larghezza massima: 3000 [mm]
 Ingombro min: 22 [mm]

Data Sheet

Maximum height: 3000 [mm]
 Maximum width: 3000 [mm]
 Min Space: 22 [mm]

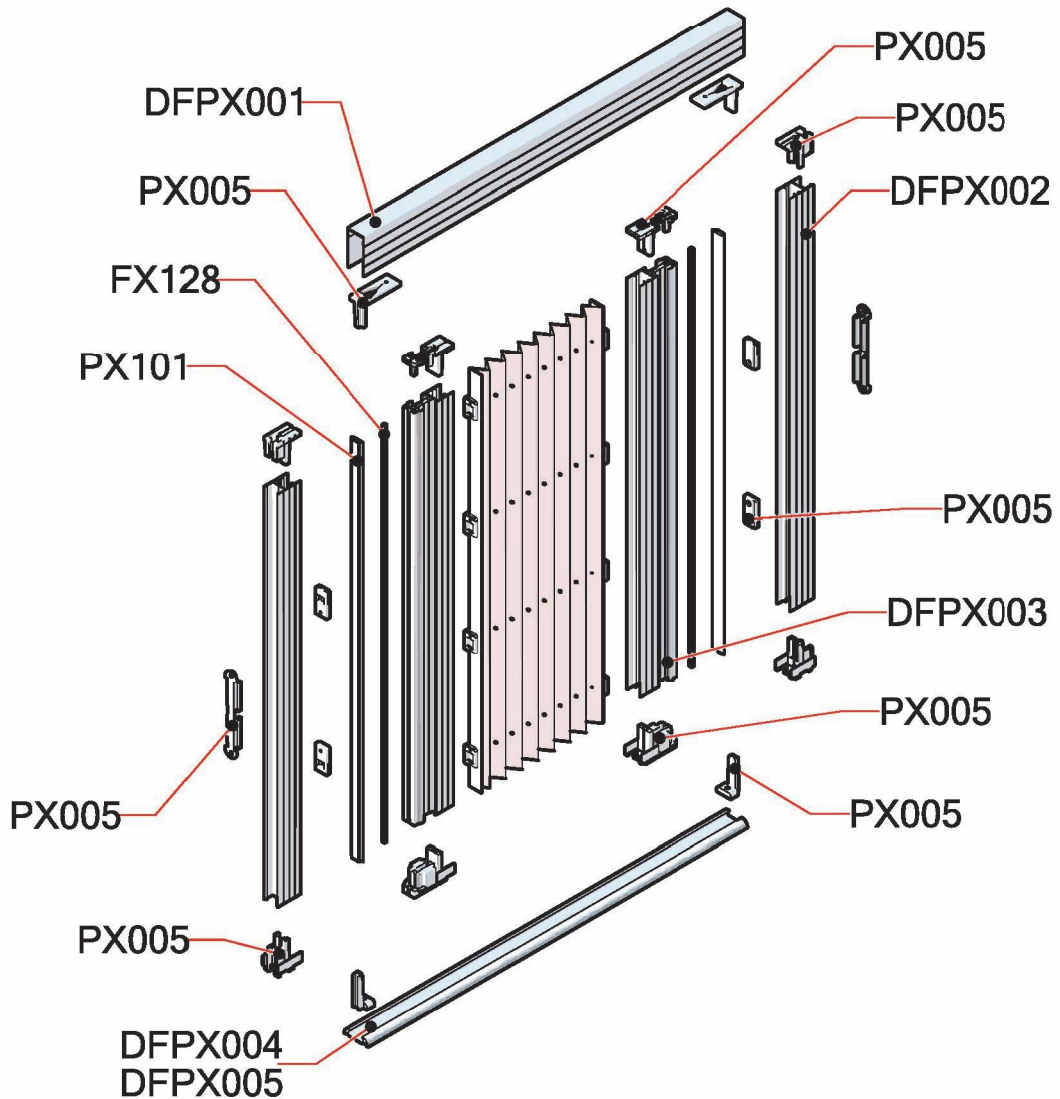

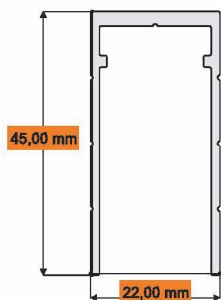
Profili di alluminio specifici - Specific aluminium profiles
Guida superiore - Upper guide

Dati Tecnici

Codice: DFPX001
 Materiale: EN-AW 6060 T5
 Peso nominale: 383 g/mt
 Finitura: Grezzo - Verniciatura

Data Sheet

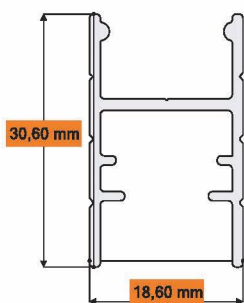
Code: DFPX001
 Material: EN-AW 6060 T5
 Nominal weight: 383 g/mt
 Finishing: Raw - Painting

Guida laterale - Lateral guide

Dati Tecnici

Codice: DFPX002
 Materiale: FN-AW 6060 T5
 Peso nominale: 309 g/mt
 Finitura: Grezzo - Verniciatura

Data Sheet

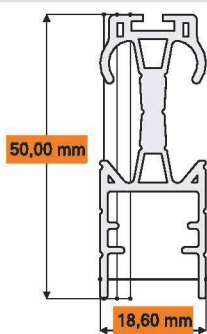
Code: DFPX002
 Material: EN-AW 6060 T5
 Nominal weight: 309 g/mt
 Finishing: Raw - Painting

Barra maniglia - Handle bar

Dati Tecnici

Codice: DFPX003
 Materiale: EN-AW 6060 T5
 Peso nominale: 733 g/mt
 Finitura: Grezzo - Verniciatura

Data Sheet

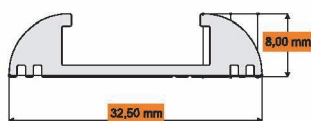
Code: DFPX003
 Material: EN-AW 6060 T5
 Nominal weight: 733 g/mt
 Finishing: Raw - Painting

Guida inferiore - Lower guide

Dati Tecnici

Codice: DFPX004
 Materiale: EN-AW 6060 T5
 Peso nominale: 295 g/mt
 Finitura: Grezzo - Verniciatura

Data Sheet

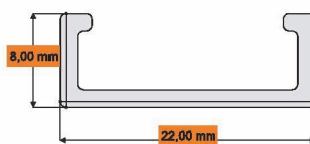
Code: DFPX004
 Material: EN-AW 6060 T5
 Nominal weight: 295 g/mt
 Finishing: Raw - Painting

Dati Tecnici

Codice: DFPX005
 Materiale: EN-AW 6060 T5
 Peso nominale: 151 g/mt
 Finitura: Grezzo - Verniciatura

Data Sheet

Code: DFPX005
 Material: EN-AW 6060 T5
 Nominal weight: 151 g/mt
 Finishing: Raw - Painting



PLIXI®

Reverse

Soluzione di base - Basic solution









Questa soluzione prevede l'acquisto di tutti i componenti sciolti, necessari alla realizzazione del sistema.
È fondamentale quindi che chi acquista abbia a disposizione le macchine e le attrezzature necessarie per la lavorazione.

This solution provides the purchase of all loose components required for manufacturing the pleated system.
The machine and the tools are necessary to proceed with production.

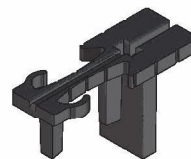
Accessori per soluzione base - Accessories for basic solution

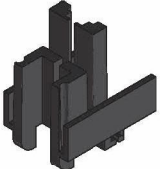
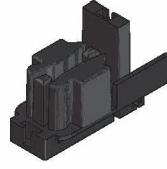
codice - code: PX005

Confezione: 100 kit (min)
Packing: 100 sets (min)

 <p>Passante per filo rete Dati Tecnici Materiale: PA6 Confezione: 12 pezzi</p> <p>Passage for wire Data Sheet Material: PA6 Packing: 12 pieces</p> <p>CP-010</p>	 <p>Tappo superiore per filo Dati Tecnici Materiale: PA6 Confezione: 2 pezzi</p> <p>Upper plug for wire Data Sheet Material: PA6 Packing: 2 pieces</p> <p>CP-005</p>	 <p>Tappo supe. barra maniglia Dati Tecnici Materiale: PA6 Confezione: 2 pezzi</p> <p>Upper plug for handlebar Data Sheet Material: PA6 Packing: 2 pieces</p> <p>CP-007</p>
 <p>Basetta di taratura filo Dati Tecnici Materiale: PA6 Confezione: 4 pezzi</p> <p>Calibration base for wire Data Sheet Material: PA6 Packing: 4 pieces</p> <p>CP-012</p>	 <p>Tappo inferiore per filo Dati Tecnici Materiale: PA6 Confezione: 2 pezzi</p> <p>Lower plug for wire Data Sheet Material: PA6 Packing: 2 pieces</p> <p>CP-006</p>	 <p>Tappo infe. barramaniglia Dati Tecnici Materiale: PA6 Confezione: 2 pezzi</p> <p>Lower plug for handlebar Data Sheet Material: PA6 Packing: 2 pieces</p> <p>CP-008</p>
 <p>Clip aggancio rapido Dati Tecnici Materiale: PA6 Confezione: 6 pezzi</p> <p>Clip for quick hook Data Sheet Material: PA6 Packing: 6 pieces</p> <p>CP-009</p>	 <p>Aggancio inf. regolabile Dati Tecnici Materiale: PA6 Confezione: 2 pezzi</p> <p>Lower adjustable bracket Data Sheet Material: PA6 Packing: 2 pieces</p> <p>CP-004</p>	 <p>Aggancio supe. regolabile Dati Tecnici Materiale: PA6 Confezione: 2 pezzi</p> <p>Upper adjustable bracket Data Sheet Material: PA6 Packing: 2 pieces</p> <p>CP-002</p>

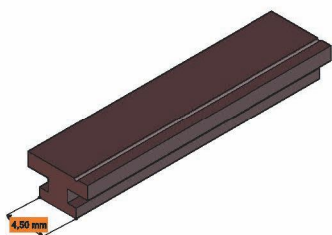
Accessori base - Basic accessories
Banda magnetica - Magnetic band

Dati Tecnici

Codice: **FX128**
 Per guida: DFPX003
 Confezione: 250/300 metri (min)

Data Sheet

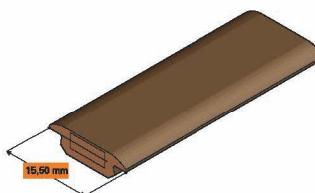
Code: **FX128**
 For guide: DFPX003
 Packing: 250/300 meters

Banda magnetica - Magnetic band

Dati Tecnici

Codice: **PX101**
 Per guida: DFPX002
 Confezione: 250/300 metri (min)

Data Sheet

Code: **PX101**
 For guide: DFPX002
 Packing: 250/300 meters

Kit viteria per assemblaggio - Kit screws for assembly

Dati Tecnici

Codice: **PX107**
 Materiale: ZBD 3 + Cr3
 Confezione: 100 kit (min)

Data Sheet

Code: **PX107**
 Material: ZBD 3 + Cr3
 Packing: 100 sets (min)

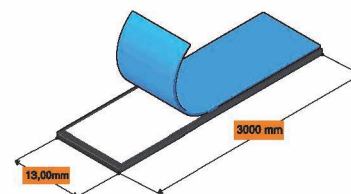
Piattina con biadesivo - Flat with double-sided tape

Dati Tecnici

Codice: **PX100**
 Materiale: PP
 Dimensioni : 13x1mm L= 2,4 - 2,6 - 3mt
 Confezione: 200 pezzi (min)

Data Sheet

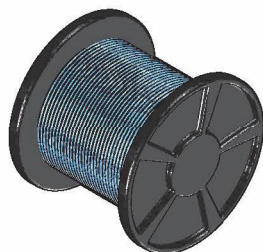
Code: **PX100**
 Material: PP
 Size: 13x1mm L= 2,4 - 2,6 - 3mt
 Packing: 200 pieces (min)

Bobina di filo - Reel wire

Dati Tecnici

Codice: **BO01GR**
 Materiale: Poliestere
 Confezione: 1.000 metri (min)

Data Sheet

Code: **BO01GR**
 Material: Polyester
 Packing: 1.000 meters (min)

PLIXI®

Reverse

Soluzione in KIT - KIT solution

Questa soluzione prevede l'acquisto di KIT rete preconfigurati completamente assemblati, riducibili in altezza a seconda delle necessità fino a 30 cm. In questo modo i tempi di realizzazione e di montaggio del sistema saranno ridotti notevolmente, oltre a non dover necessitare di macchine specifiche per la lavorazione. I rimanenti accessori per il completamento della zanzariera vanno acquistati separatamente.

This solution provides the purchase of pre-assembled kits of mesh, with the possibility to reduce the heights according to the needs. In this way the times of manufacture for assembly the system will be reduced considerably: no specific machines are required for production. The remaining accessories for completing the insect screen must be purchased separately.

CODICE CODE	RETE PLISSÈ PLEATED NET				FILO WIRE	PIATTINA STRAP
	ALTEZZA HEIGHT	LARGHEZZA WIDTH	SPESSORE THICKNESS	COLORE COLOR	CODICE CODE	LUNGHEZZA LENGHT
PXKRE170125G	1,70 [mt]	96/125 [cm]	15 [mm]	GRIGIO GRAY	BO01	1,70 [mt]
PXKRE170150G	1,70 [mt]	126/150 [cm]	15 [mm]	GRIGIO GRAY	BO01	1,70 [mt]
PXKRE200125G	2,00 [mt]	96/125 [cm]	15 [mm]	GRIGIO GRAY	BO01	2,00 [mt]
PXKRE200150G	2,00 [mt]	126/150 [cm]	15 [mm]	GRIGIO GRAY	BO01	2,00 [mt]
PXKRE230125G	2,30 [mt]	96/125 [cm]	15 [mm]	GRIGIO GRAY	BO01	2,30 [mt]
PXKRE230150G	2,30 [mt]	126/150 [cm]	15 [mm]	GRIGIO GRAY	BO01	2,30 [mt]
PXKRE260125G	2,60 [mt]	96/125 [cm]	15 [mm]	GRIGIO GRAY	BO01	2,60 [mt]
PXKRE260150G	2,60 [mt]	126/150 [cm]	15 [mm]	GRIGIO GRAY	BO01	2,60 [mt]
PXKRE300125G	3,00 [mt]	96/125 [cm]	15 [mm]	GRIGIO GRAY	BO01	3,00 [mt]
PXKRE300150G	3,00 [mt]	126/150 [cm]	15 [mm]	GRIGIO GRAY	BO01	3,00 [mt]

Nota:

I kit preconfigurati elencati, sono da considerarsi completi di:

- fissaggio delle 2 piattine alle estremità delle rete;
- Foratura di rete e piattine;
- Inserimento dei fili in poliestere
- Assemblaggio degli accessori specifici direttamente nel kit.

Notice:

The pre-assembled kits above include:

- 2 flats already placed on the edges of mesh;
- Drilling of mesh and flats;
- Polyester wire insertion;
- Components already placed on the kit mesh.

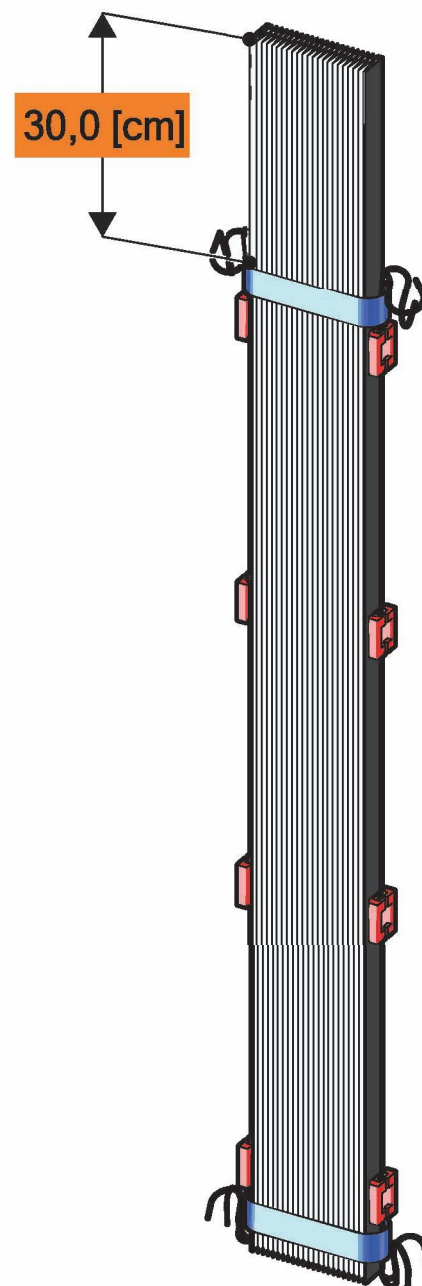

Soluzione in KIT - KIT solution
Accessori per soluzione in kit - Accessories for kit solution
codice - code: PX006

 Confezione: 100 kit (min)
 Packing: 100 sets (min)



Basetta di taratura filo
Dati Tecnici
 Materiale: PA6
 Confezione: 4 pezzi

Calibration base for wire
Data Sheet
 Material: PA6
 Packing: 4 pieces

CP-012



Tappo superiore per filo
Dati Tecnici
 Materiale: PA6
 Confezione: 2 pezzi

Upper plug for wire
Data Sheet
 Material: PA6
 Packing: 2 pieces

CP-005

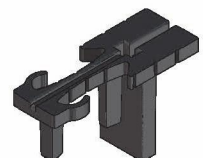

Tappo superiore barra maniglia
Dati Tecnici
 Materiale: PA6
 Confezione: 2 pezzi

Upper plug for handlebar
Data Sheet
 Material: PA6
 Packing: 2 pieces

CP-007

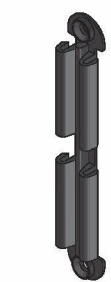

Clip aggancio rapido
Dati Tecnici
 Materiale: PA6
 Confezione: 6 pezzi

Clip for quick hook
Data Sheet
 Material: PA6
 Packing: 6 pieces

CP-009

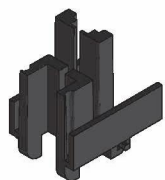

Tappo inferiore per filo
Dati Tecnici
 Materiale: PA6
 Confezione: 2 pezzi

Lower plug for wire
Data Sheet
 Material: PA6
 Packing: 2 pieces

CP-006

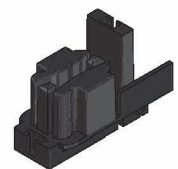

Tappo inferiore barramaniglia
Dati Tecnici
 Materiale: PA6
 Confezione: 2 pezzi

Lower plug for handlebar
Data Sheet
 Material: PA6
 Packing: 2 pieces

CP-008



Aggancio inferiore regolabile
Dati Tecnici
 Materiale: PA6
 Confezione: 2 pezzi

Lower adjustable bracket
Data Sheet
 Material: PA6
 Packing: 2 pieces

CP-004



Aggancio superiore regolabile
Dati Tecnici
 Materiale: PA6
 Confezione: 2 pezzi

Upper adjustable bracket
Data Sheet
 Material: PA6
 Packing: 2 pieces

CP-002

PLIXI®

Reverse

Accessori base - Basic accessories

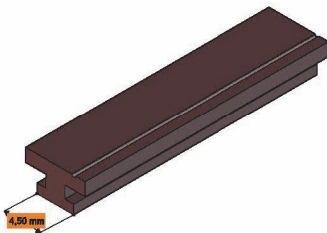
Banda magnetica - Magnetic band**Dati Tecnici**

Codice: FX128
Per guida: DFPX003
Confezione: 250/300 metri (min)

Data Sheet

Code: FX128
For guide: DFPX003
Packing: 250/300 meters

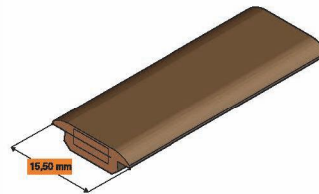
Banda magnetica - Magnetic band**Dati Tecnici**

Codice: PX101
Per guida: DFPX002
Confezione: 250/300 metri (min)

Data Sheet

Code: PX101
For guide: DFPX002
Packing: 250/300 meters

Kit viteria per assemblaggio - Kit screws for assembly**Dati Tecnici**

Codice: PX108
Materiale: ZBD 3 + Cr3
Confezione: 100 kit (min)

Data Sheet

Code: PX108
Material: ZBD 3 + Cr3
Packing: 100 sets (min)

Alternative tra accessori - Alternative accessories

Alternativa 1 - Alternative 1

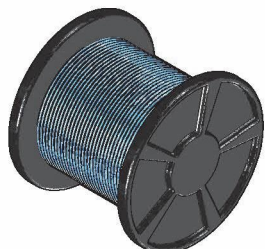

BOBINA DI FILO poliestere

Dati Tecnici

Codice: **BO01GR**
 Materiale: Poliestere
 Confezione: 1.000 metri (min)

REEL WIRE polyester

Data Sheet

Code: **BO01GR**
 Material: Polyester
 Packing: 1.000 meters (min)

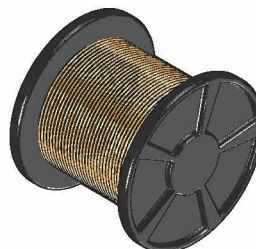

BOBINA DI FILO kevlar

Dati Tecnici

Codice: **BO02**
 Materiale: Kevlar
 Confezione: 1.000 metri (min)

REEL WIRE kevlar

Data Sheet

Code: **BO02**
 Material: Kevlar
 Packing: 1.000 meters (min)

PLIXI®*Verticale - Vertical***Dati Tecnici**

Altezza massima: 1800 [mm]
Larghezza massima: 1600 [mm]
Ingombro min: 22 [mm]

Data Sheet

Maximum height: 1800 [mm]
Maximum width: 1600 [mm]
Min Space: 22 [mm]

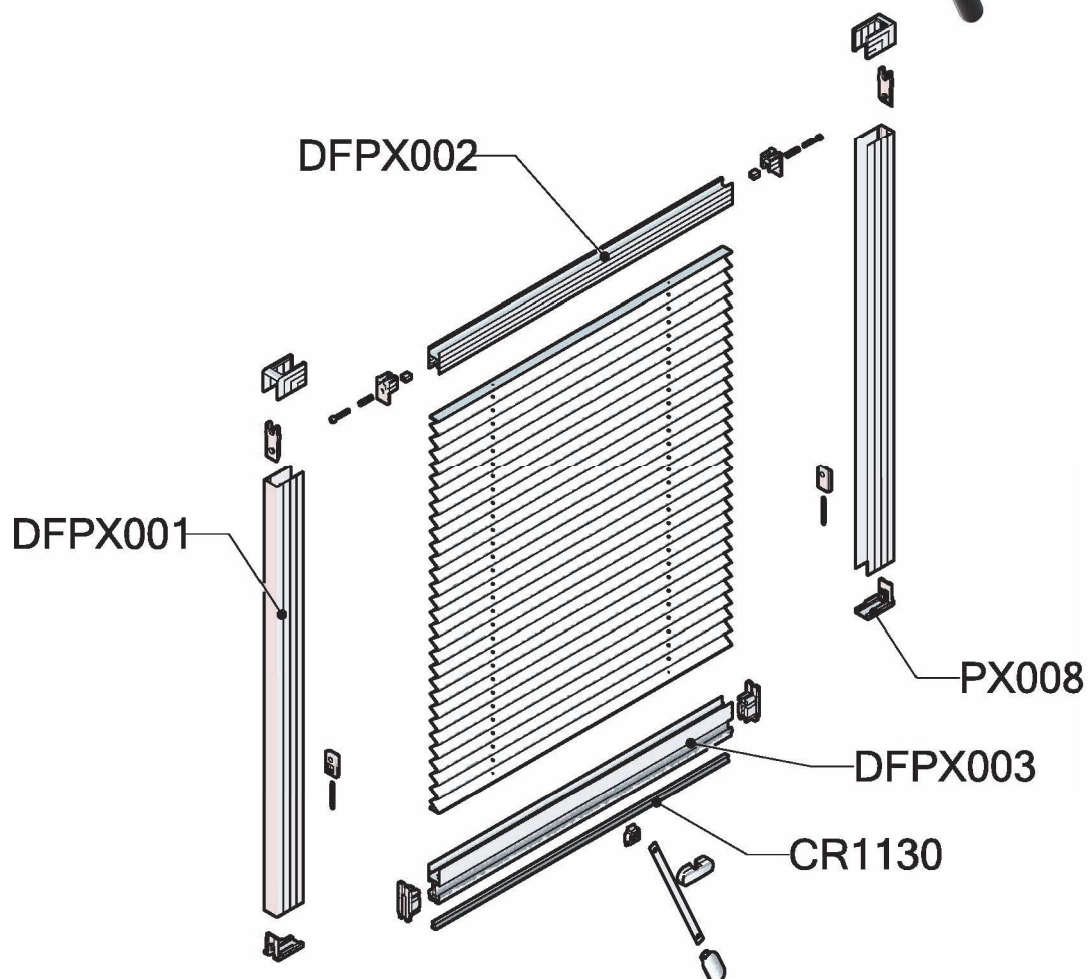
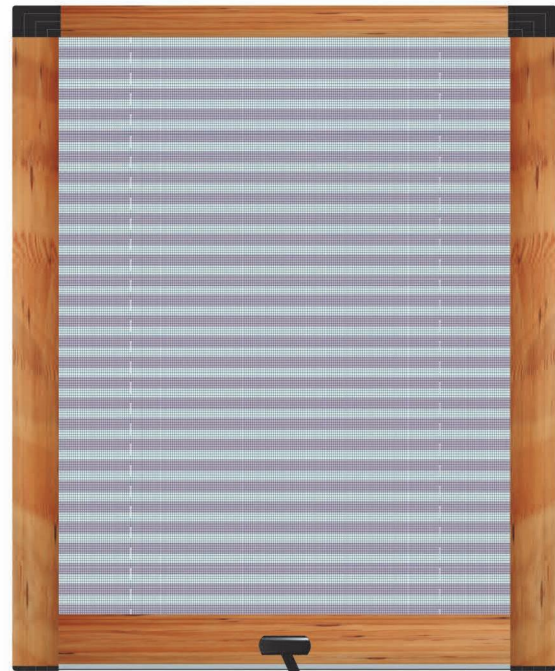

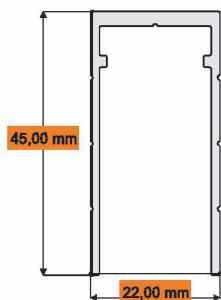
Profili di alluminio specifici - Specific aluminium profiles
Guida superiore - Upper guide

Dati Tecnici

Codice: DFPX001
 Materiale: EN-AW 6060 T5
 Peso nominale: 383 g/mt
 Finitura: Grezzo - Verniciatura

Data Sheet

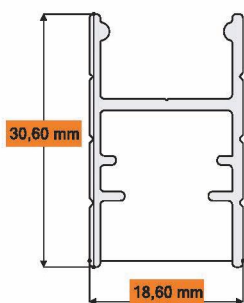
Code: DFPX001
 Material: EN-AW 6060 T5
 Nominal weight: 383 g/mt
 Finishing: Raw - Painting

Guida laterale - Lateral guide

Dati Tecnici

Codice: DFPX002
 Materiale: FN-AW 6060 T5
 Peso nominale: 309 g/mt
 Finitura: Grezzo - Verniciatura

Data Sheet

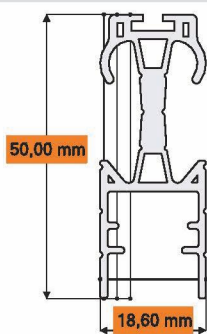
Code: DFPX002
 Material: EN-AW 6060 T5
 Nominal weight: 309 g/mt
 Finishing: Raw - Painting

Barra maniglia - Handle bar

Dati Tecnici

Codice: DFPX003
 Materiale: EN-AW 6060 T5
 Peso nominale: 733 g/mt
 Finitura: Grezzo - Verniciatura

Data Sheet

Code: DFPX003
 Material: EN-AW 6060 T5
 Nominal weight: 733 g/mt
 Finishing: Raw - Painting

PLIXI®

Verticale - Vertical

Soluzione di base - Basic solution

Questa soluzione prevede l'acquisto di tutti i componenti sciolti, necessari alla realizzazione del sistema.
È fondamentale quindi che chi acquista abbia a disposizione le macchine e le attrezzature necessarie per la lavorazione.

This solution provides the purchase of all loose components required for manufacturing the pleated system.
The machine and the tools are necessary to proceed with production.

Accessori per soluzione base - Accessories for basic solution

codice - code: PX007

Confezione: 100 kit (min)
Packing: 100 sets (min)

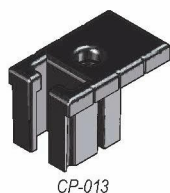

CP-013

Tappo per molla

Dati Tecnici

Materiale: POM
Confezione: 2 pezzi

Plug for spring

Data Sheet

Material: POM
Packing: 2 pieces



CP-014

Forcella di sostegno

Dati Tecnici

Materiale: POM
Confezione: 2 pezzi

Support fork

Data Sheet

Material: POM
Packing: 2 pieces

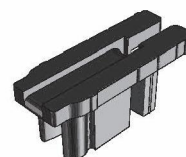

CP-015

Tappo barra maniglia

Dati Tecnici

Materiale: POM
Confezione: 2 pezzi

Plug for handlebar

Data Sheet

Material: POM
Packing: 2 pieces

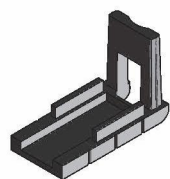

CP-016

Tappo inferiore

Dati Tecnici

Materiale: POM
Confezione: 2 pezzi

Lower plug

Data Sheet

Material: POM
Packing: 2 pieces



CP-017

Basetta di taratura filo

Dati Tecnici

Materiale: POM
Confezione: 2 pezzi

Calibration base for wire

Data Sheet

Material: POM
Packing: 2 pieces

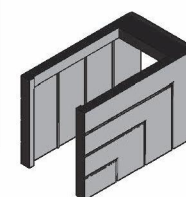

CP-018

Tappo superiore

Dati Tecnici

Materiale: POM
Confezione: 2 pezzi

Upper plug

Data Sheet

Material: POM
Packing: 2 pieces



CP-019

Aggancio asta rotante

Dati Tecnici

Materiale: POM
Confezione: 1 pezzo

Hook for rotating rod

Data Sheet

Material: POM
Packing: 1 piece



CP-020

Tappo di chiusura aggancio

Dati Tecnici

Materiale: POM
Confezione: 1 pezzo

Hook closure plug

Data Sheet

Material: POM
Packing: 1 piece



CP-021

Maniglia ad inserimento

Dati Tecnici

Materiale: POM
Confezione: 1 pezzo

Plug handle

Data Sheet

Material: POM
Packing: 1 piece



CP-009

Clip aggancio rapido

Dati Tecnici

Materiale: PA6
Confezione: 1 pezzo

Clip for quick hook

Data Sheet

Material: PA6
Packing: 1 piece



CP-006

Asta rotante

Dati Tecnici

Materiale: EN-AW 6060 T5
Confezione: 1 pezzo

Rotating rod

Data Sheet

Material: EN-AW 6060 T5
Packing: 1 piece

Accessori base - Basic accessories
Spazzolino barra maniglia - Weatherstrip for handle bar
Dati Tecnici

Codice: CR1130
 Misura: 6x9 3P
 Confezione: 900 - 1.300 metri (min)

Data Sheet

Code: CR1130
 Size: 6x9 3P
 Packing: 900 - 1.300 meters (min)

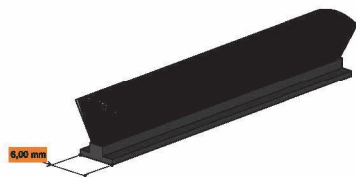
Bobina di filo - Reel wire
Dati Tecnici

Codice: BO01GR
 Materiale: Poliestere
 Confezione: 1.000 metri (min)

Data Sheet

Code: BO01GR
 Material: Polyester
 Packing: 1.000 meters (min)

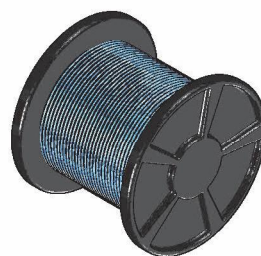
Kit viteria per assemblaggio - Kit screws for assembly
Dati Tecnici

Codice: PX109
 Materiale: ZBD 3 + Cr3
 Confezione: 100 kit (min)

Data Sheet

Code: PX109
 Material: ZBD 3 + Cr3
 Packing: 100 sets (min)

Piattina con biadesivo - Flat with double-sided tape
Dati Tecnici

Codice: PX100
 Materiale: PP
 Dimensioni : 13x1mm L= 2,4 - 2,6 - 3mt
 Confezione: 200 pezzi (min)

Data Sheet

Code: PX100
 Material: PP
 Size: 13x1mm L= 2,4 - 2,6 - 3mt
 Packing: 200 pieces (min)

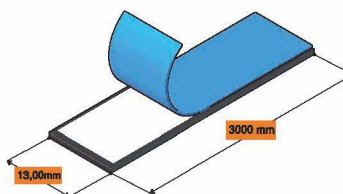

PLIXI®

Verticale - Vertical

Soluzione in KIT - KIT solution

Questa soluzione prevede l'acquisto di KIT rete preconfigurati completamente assemblati, riducibili in larghezza a seconda delle necessità fino a 30 cm. In questo modo i tempi di realizzazione e di montaggio del sistema saranno ridotti notevolmente, oltre a non dover necessitare di macchine specifiche per la lavorazione. I rimanenti accessori per il completamento della zanzariera vanno acquistati separatamente.

This solution provides the purchase of pre-assembled kits of mesh, with the possibility to reduce the width according to the needs. In this way the times of manufacture for assembly the system will be reduced considerably: no specific machines are required for production. The remaining accessories for completing the insect screen must be purchased separately.

CODICE CODE	RETE PLISSÈ PLEATED NET				FILO WIRE	PIATTINA FLAT
	ALTEZZA HEIGHT	LARGHEZZA WIDTH	SPESSORE THICKNESS	COLORE COLOR	CODICE CODE	LUNGHEZZA LENGTH
PVKIT100100G	100/120 [cm]	70/100 [cm]	15 [mm]	GRIGIO GRAY	BO01	1,00 [mt]
PVKIT100130G	100/120 [cm]	100/130 [cm]	15 [mm]	GRIGIO GRAY	BO01	1,30 [mt]
PVKIT100160G	100/120 [cm]	130/160 [cm]	15 [mm]	GRIGIO GRAY	BO01	1,60 [mt]
PVKIT140100G	120/140 [cm]	70/100 [cm]	15 [mm]	GRIGIO GRAY	BO01	1,00 [mt]
PVKIT140130G	120/140 [cm]	100/130 [cm]	15 [mm]	GRIGIO GRAY	BO01	1,30 [mt]
PVKIT140160G	120/140 [cm]	130/160 [cm]	15 [mm]	GRIGIO GRAY	BO01	1,60 [mt]
PVKIT160100G	140/160 [cm]	70/100 [cm]	15 [mm]	GRIGIO GRAY	BO01	1,00 [mt]
PVKIT160130G	140/160 [cm]	100/130 [cm]	15 [mm]	GRIGIO GRAY	BO01	1,30 [mt]
PVKIT160160G	140/160 [cm]	130/160 [cm]	15 [mm]	GRIGIO GRAY	BO01	1,60 [mt]

Nota:

I kit preconfigurati elencati sono da considerarsi completi di:

- fissaggio delle 2 piattine alle estremità delle rete;
- Foratura di rete e piattine;
- Inserimento dei fili in poliestere;
- Assemblaggio degli accessori specifici direttamente nel kit.

Notice:





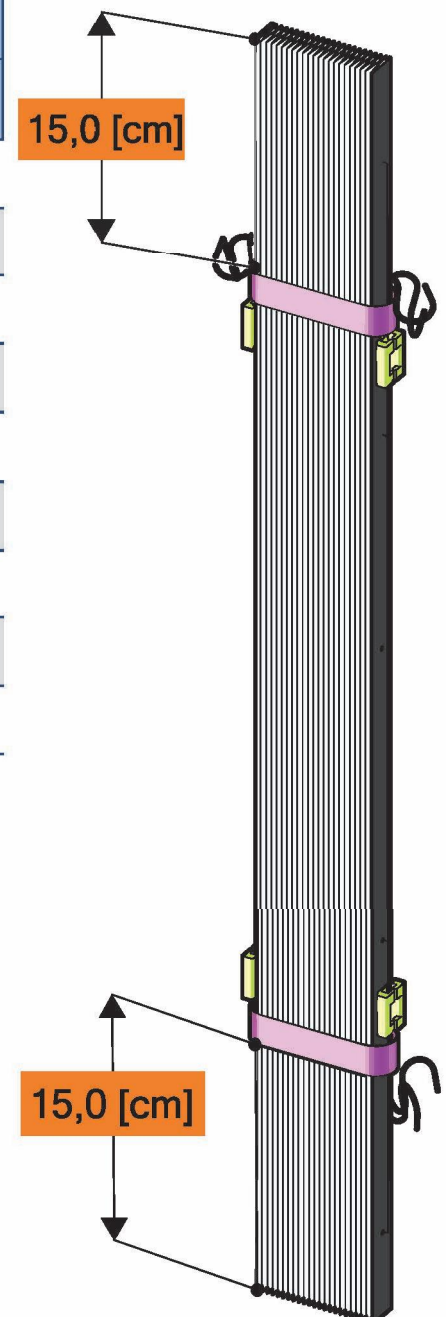



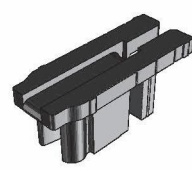
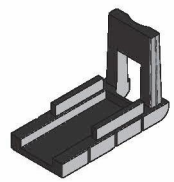

The pre-assembled kits above include:

- 2 flats already placed on the edges of mesh;
- Drilling of mesh and flats;
- Polyester wire insertion;
- Components already placed on the kit mesh.

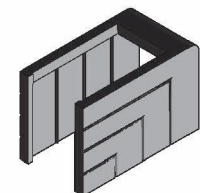

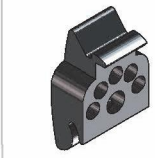
Soluzione in KIT - KIT solution
Accessori per soluzione in kit - Accessories for kit solution
codice - code: PX008

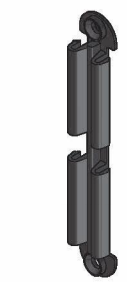
 Confezione: 100 kit (min)
 Packing: 100 sets (min)

 <p>Tappo per molla Dati Tecnici Materiale: POM Confezione: 2 pezzi</p> <p>Plug for spring Data Sheet Material: POM Packing: 2 pieces</p> <p>CP-013</p>	 <p>Forcella di sostegno Dati Tecnici Materiale: POM Confezione: 2 pezzi</p> <p>Support fork Data Sheet Material: POM Packing: 2 pieces</p> <p>CP-014</p>	 <p>Tappo barra maniglia Dati Tecnici Materiale: POM Confezione: 2 pezzi</p> <p>Plug for handlebar Data Sheet Material: POM Packing: 2 pieces</p> <p>CP-015</p>
 <p>Tappo inferiore Dati Tecnici Materiale: POM Confezione: 2 pezzi</p> <p>Lower plug Data Sheet Material: POM Packing: 2 pieces</p> <p>CP-016</p>	 <p>Basetta di taratura filo Dati Tecnici Materiale: POM Confezione: 2 pezzi</p> <p>Calibration base for wire Data Sheet Material: POM Packing: 2 pieces</p> <p>CP-017</p>	 <p>Tappo superiore Dati Tecnici Materiale: POM Confezione: 2 pezzi</p> <p>Upper plug Data Sheet Material: POM Packing: 2 pieces</p> <p>CP-018</p>
 <p>Aggancio asta rotante Dati Tecnici Materiale: POM Confezione: 1 pezzo</p> <p>Hook for rotating rod Data Sheet Material: POM Packing: 1 piece</p> <p>CP-019</p>	 <p>Tappo di chiusura aggancio Dati Tecnici Materiale: POM Confezione: 1 pezzo</p> <p>Hook closure plug Data Sheet Material: POM Packing: 1 piece</p> <p>CP-020</p>	 <p>Maniglia ad inserimento Dati Tecnici Materiale: POM Confezione: 1 pezzo</p> <p>Plug handle Data Sheet Material: POM Packing: 1 piece</p> <p>CP-021</p>
 <p>Clip aggancio rapido Dati Tecnici Materiale: PA6 Confezione: 1 pezzo</p> <p>Clip for quick hook Data Sheet Material: PA6 Packing: 1 piece</p> <p>CP-009</p>	 <p>Asta rotante Dati Tecnici Materiale: EN-AW 6060 T5 Confezione: 1 pezzo</p> <p>Rotating rod Data Sheet Material: EN-AW 6060 T5 Packing: 1 piece</p> <p>CP-006</p>	

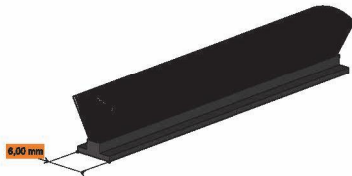
PLIXI®*Verticale - Vertical**Accessori base - Basic accessories***Spazzolino barra maniglia - Weatherstrip for handle bar****Dati Tecnici**

Codice: CR1130
Misura: 6x9 3P
Confezione: 900 - 1.300 metri
(min)

Data Sheet

Code: CR1130
Size: 6x9 3P
Packing: 900 - 1.300 meters
(min)

Kit viteria per assemblaggio - Kit screws for assembly**Dati Tecnici**

Codice: PX109
Materiale: ZBD 3 + Cr3
Confezione: 100 kit (min)

Data Sheet

Code: PX109
Material: ZBD 3 + Cr3
Packing: 100 sets (min)

Alternative tra accessori - Alternative accessories

Alternativa 1 - Alternative 1

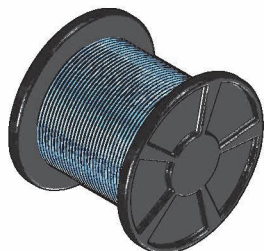

BOBINA DI FILO poliestere

Dati Tecnici

Codice: **BO01GR**
 Materiale: Poliestere
 Confezione: 1.000 metri (min)

REEL WIRE polyester

Data Sheet

Code: **BO01GR**
 Material: Polyester
 Packing: 1.000 meters (min)

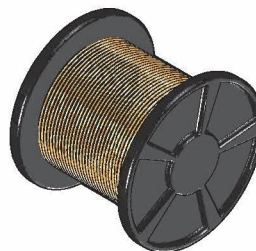

BOBINA DI FILO kevlar

Dati Tecnici

Codice: **BO02**
 Materiale: Kevlar
 Confezione: 1.000 metri (min)

REEL WIRE kevlar

Data Sheet

Code: **BO02**
 Material: Kevlar
 Packing: 1.000 meters (min)